

Slant leg bench

H83T76

Assembly Instructions

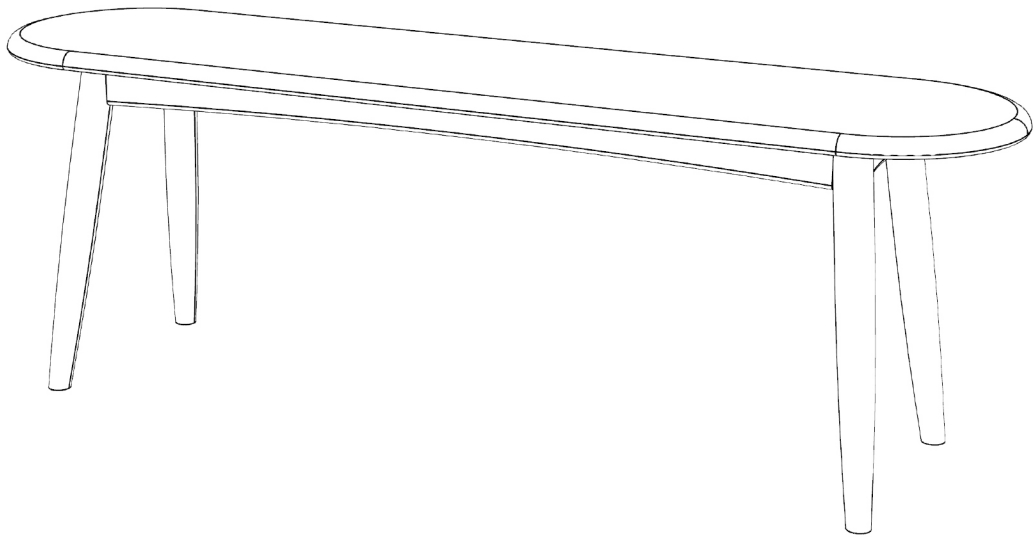





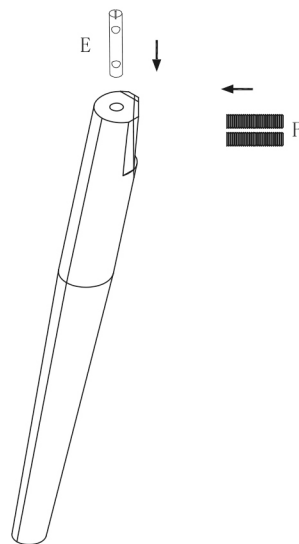

The assembly steps are as follows:

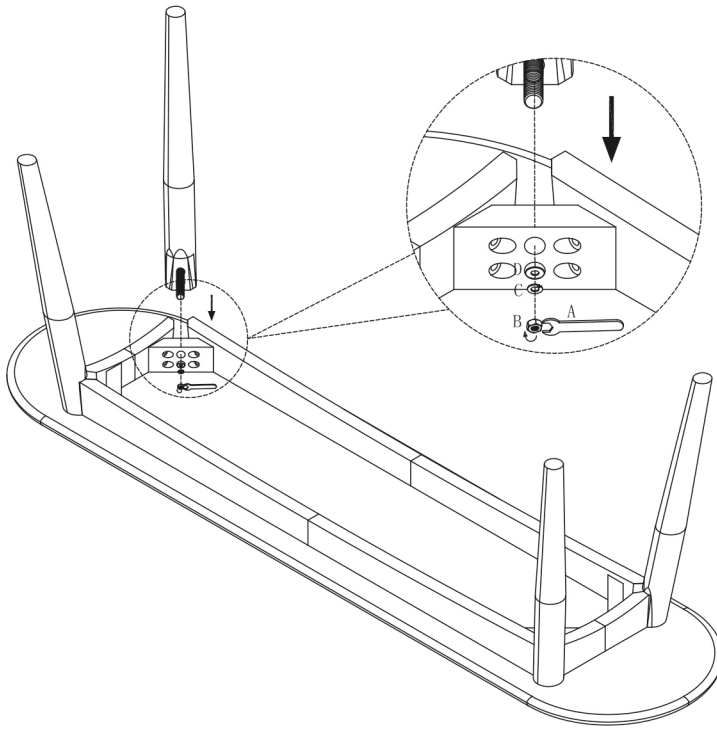
Step 1: As shown in the diagram below, insert E into the hole at the top of each leg and then screw F into the two holes of E.

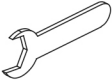

Step 2: Lay the bench top facedown on a flat, clean and non-abrasive surface. Attach the legs to the bench top as shown in the diagram below. Make sure you fit the hardware together in the correct order.

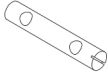

| | | | | | |
|--|--|--|--|--|--|
|  |  |  |  |  |  |
| A. Open-end wrench x 1 | B. Nuts (Ø6) x 8 | C. Split washers (Ø6) x 8 | D. Flat washers (Ø6) x 8 | E. Twin hole cross dowel barrel nuts (Ø10) x 4 | F. Grub screws (Ø6) x 8 |